

Vertical Hit and Miss VHM1  
Initial Design Drawing.

02/20/2013  
David Kerpel

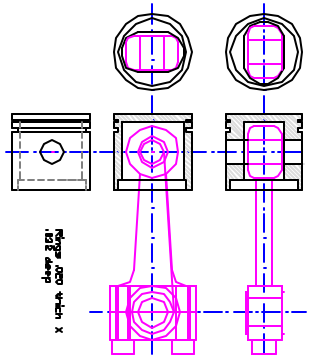

100% ASB Valve x  
100% ASB

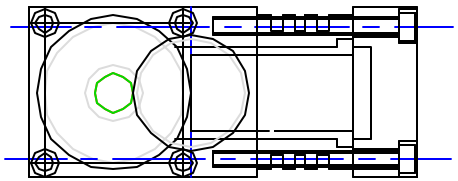
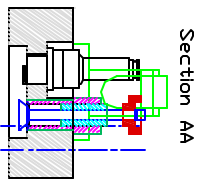

Section AA

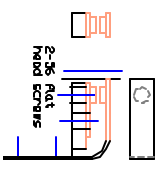

2-3/8 Flat  
Head Screws

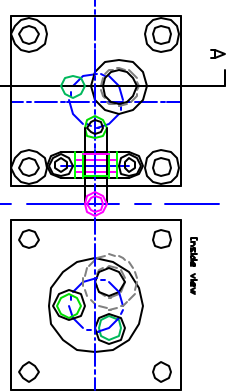

A

Inside View

100% ASB  
VALVE STEM ASB

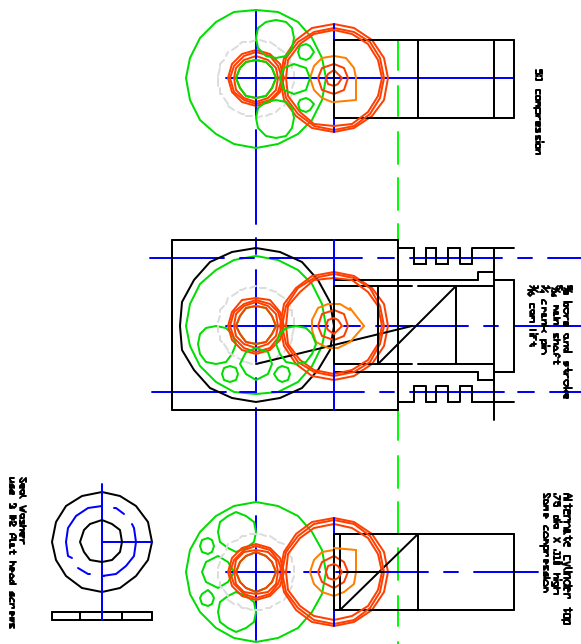
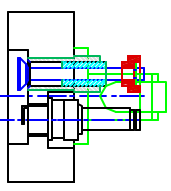

3D comparison

Internal and external  
to main body  
3/8 diam 1/4  
thick

Alignment of 1/4  
thick  
3/8 diam 1/4  
thick comparison

Steel Vent  
Use 3 flat head screws

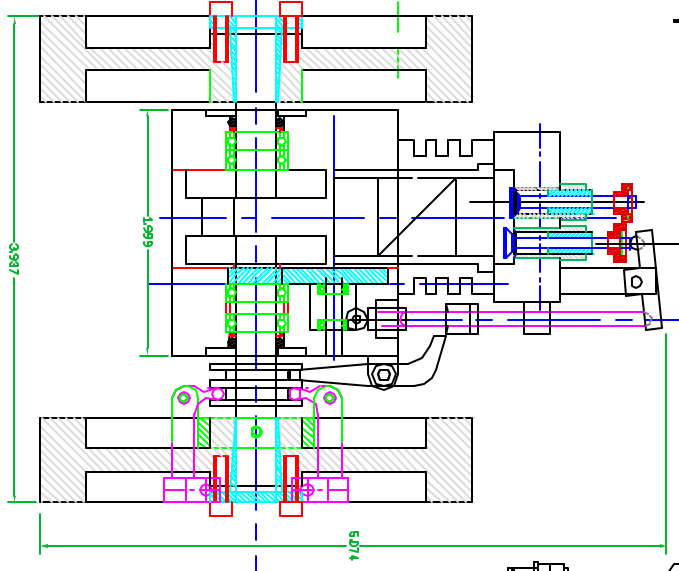

1.9993

3.917

5.071

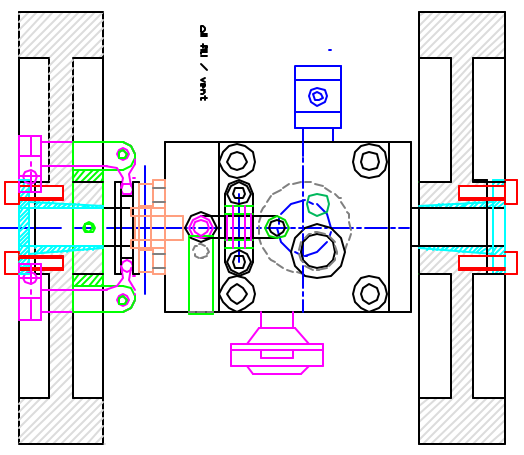
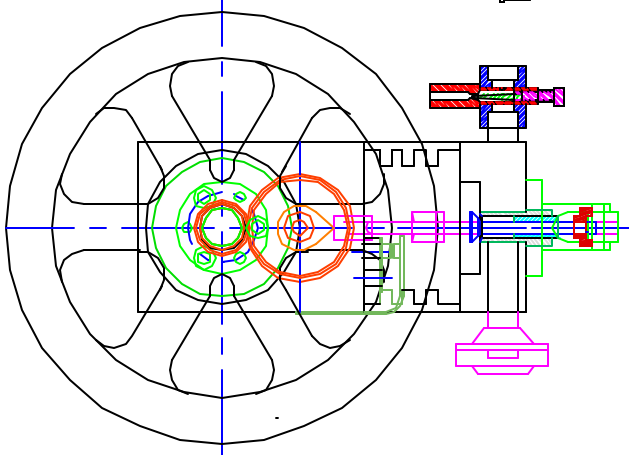

all flat / vent

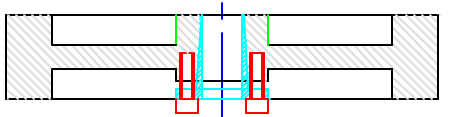

Bottom Lock for  
valve stem  
and 3 main screws  
100% ASB  
1/4 diam 1/4  
thick

